

HFD3

SUBMINIATURE SIGNAL RELAY

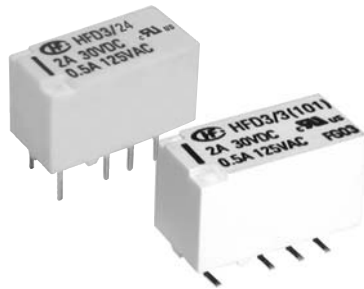

File No.:E133481



Features

- High dielectric withstand voltage of 2000VAC (between coil and contacts)
- High contact capacity: 2A 30VDC
- Surge withstand voltage up to 2500VAC (between coil and contacts)
- SMT and DIP types available
- Bifurcated contacts
- Single side stable and latching type available
- Environmental friendly product (RoHS compliant)
- Outline Dimensions: 15.0 x 7.5 x 9.0 mm

CONTACT DATA

Contact arrangement	2C
Initial contact resistance Max.	50mΩ
Contact material	AgNi + Au plated
Contact rating (Res. load)	2A 30VDC 0.5A 125VAC
Max. switching power	62.5VA / 60W
Max. switching voltage	250VAC / 220VDC
Max. switching current	2A
Min. applicable load	10mV 10μA
Mechanical life	1 x 10 ⁸ OPS
Electrical life	5 x 10 ⁵ OPS (at 1A 30VDC)
	1 x 10 ⁵ OPS (at 2A 30VDC)
	1 x 10 ⁵ OPS (at 0.5A 125VAC)

COIL

Coil power	Single side stable	140mW
	1 coil latching	100mW
	2 coils latching	200mW
Temperature rise	Max. 50°C	

CHARACTERISTICS

Initial insulation resistance		1000MΩ (at 500VDC)
Dielectric strength	Between coil & contacts	2000VAC 1min.
	Between open contacts	1000VAC 1min.
	Between contact sets	1500VAC 1min.
Surge withstand voltage		
Between open contacts (10×160μs)		1500VAC (FCC part 68)
Between coil & contacts (2×10μs)		2500VAC (Bellcore)
Operate time (Set time)		Max. 4ms
Release time (Reset time)		Max. 4ms
Ambient temperature		-40°C to +85°C
Humidity		35 to 85% RH
Vibration resistance	Functional	10 to 55Hz 3.3mm DA
	Destructive	10 to 55Hz 5.0mm DA
Shock resistance	Functional	750m/s ² (75g)
	Destructive	1000m/s ² (100g)
Termination		DIP, SMT
Unit weight		Approx. 2g
Construction		Sealed IP67

SAFETY APPROVAL RATINGS

UL&CUR	2A 30VDC 0.5A 125VAC
--------	-------------------------



HONGFA RELAY

ISO9001、ISO/TS16949、ISO14001、OHSAS18001 CERTIFIED

2006 Rev. 1.10

COIL DATA

Single side stable

at 20°C

Order Number	Nominal Voltage (VDC)	Nominal Current (mA)	Pick-up Voltage (VDC)	Drop-out Voltage (VDC)	Coil Resistance ($\Omega \pm 10\%$)	Nominal Power (mW)	Max. Allowable Voltage (VDC)
HFD3/1.5	1.5	93.8	1.13	0.15	16	140	2.2
HFD3/3	3	46.7	2.25	0.3	64.3	140	4.5
HFD3/4.5	4.5	31	3.38	0.45	145	140	6.7
HFD3/5	5	28.1	3.75	0.5	178	140	7.5
HFD3/6	6	23.3	4.5	0.6	257	140	9
HFD3/9	9	15.5	6.75	0.9	579	140	13.5
HFD3/12	12	11.7	9	1.2	1028	140	18
HFD3/24	24	5.8	18	2.4	4114	140	36
HFD3/48	48	5.6	36	4.8	8533	270	57.6

1 coil latching

at 20°C

Order Number	Nominal Voltage (VDC)	Nominal Current (mA)	Set Voltage (VDC)	Reset Voltage (VDC)	Coil Resistance ($\Omega \pm 10\%$)	Nominal Power (mW)	Max. Allowable Voltage (VDC)
HFD3/1.5-L1	1.5	66.7	1.13	1.13	22.5	100	2.7
HFD3/3-L1	3	33.3	2.25	2.25	90	100	5.4
HFD3/4.5-L1	4.5	22.2	3.38	3.38	203	100	8.1
HFD3/5-L1	5	20	3.75	3.75	250	100	9
HFD3/6-L1	6	16.7	4.5	4.5	360	100	10.8
HFD3/9-L1	9	11.1	6.75	6.75	810	100	16.2
HFD3/12-L1	12	8.3	9	9	1440	100	21.6
HFD3/24-L1	24	4.2	18	18	5760	100	43.2

2 coil latching

at 20°C

Order Number	Nominal Voltage (VDC)	Nominal Current (mA)	Set Voltage (VDC)	Reset Voltage (VDC)	Coil Resistance ($\Omega \pm 10\%$)	Nominal Power (mW)	Max. Allowable Voltage (VDC)
HFD3/1.5-L2	1.5	133.9	1.13	1.13	11.2	200	2.2
HFD3/3-L2	3	66.7	2.25	2.25	45	200	4.5
HFD3/4.5-L2	4.5	44.5	3.38	3.38	101	200	6.7
HFD3/5-L2	5	40	3.75	3.75	125	200	7.5
HFD3/6-L2	6	33.3	4.5	4.5	180	200	9.0
HFD3/9-L2	9	22.2	6.75	6.75	405	200	13.5
HFD3/12-L2	12	16.7	9	9	720	200	18
HFD3/24-L2	24	8.3	18	18	2880	200	36

Notes: When user's requirements can't be found in the above table, please counsel with Hongfa for relay application support.

ORDERING INFORMATION

Type	HFD3 /	24	L2	S	R	XXX
Coil voltage	1.5, 3, 4.5, 5, 6, 9, 12, 24, 48VDC					
Sort	L1: 1 coil latching	L2: 2 coils latching	Nil: Single side stable			
Terminal type	S: SMT	Nil: DIP				
Packing style	R: Tape and reel packing (Only for SMT type)			Nil: Tube packing		
Customer special code	(Only for special requirements)					

Notes: (1) 48VDC coil voltage is only for single side stable version.
 (2) HFD3 is also RoHS compliant.

OUTLINE DIMENSIONS, WIRING DIAGRAM AND PC BOARD LAYOUT

Unit: mm

Outline Dimensions
(DIP type)

Single side stable & 1 coil latching

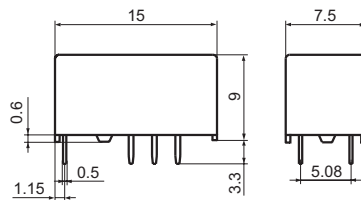

2 coils latching

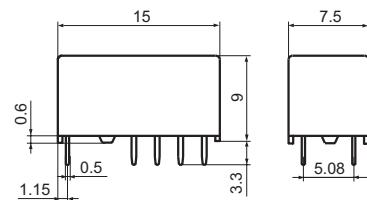

Remark: The general tolerance is $\pm 0.2\text{mm}$.

PCB Layout
(DIP type)

Single side stable & 1 coil latching

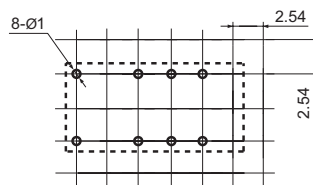

2 coils latching

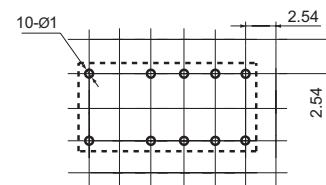

Remark: The general tolerance is $\pm 0.1\text{mm}$.

OUTLINE DIMENSIONS, WIRING DIAGRAM AND PC BOARD LAYOUT

Unit: mm

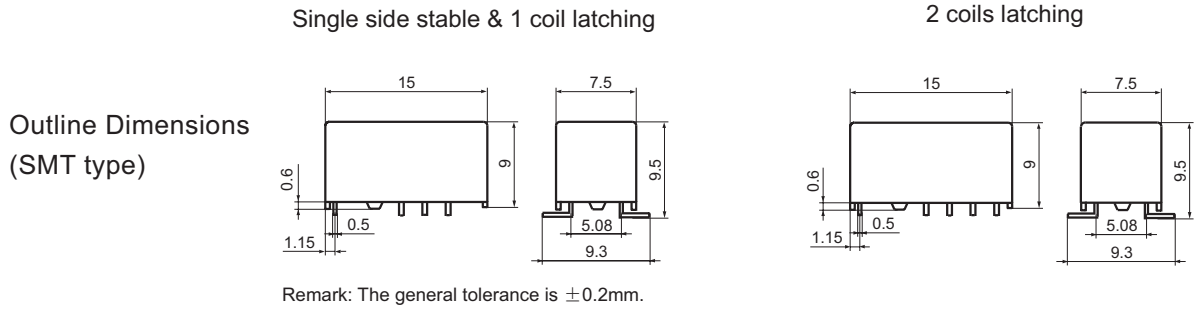

Remark: The general tolerance is $\pm 0.2\text{mm}$.

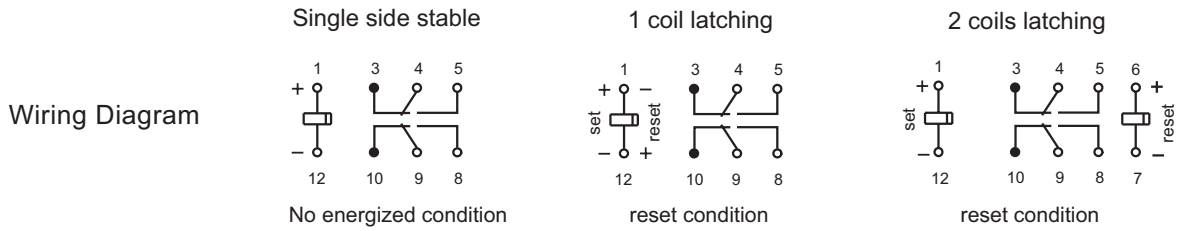
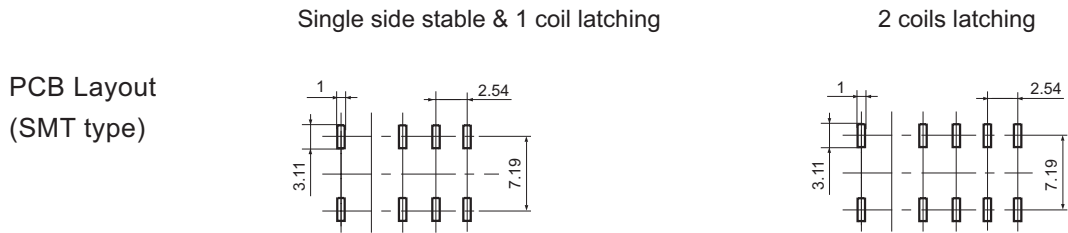

CHARACTERISTIC CURVES

MAXIMUM SWITCHING POWER

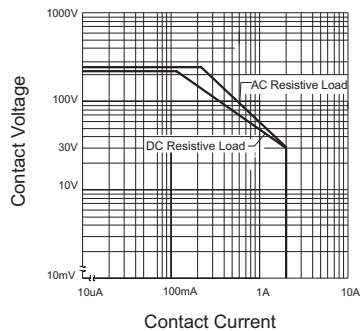

LIFE CURVE

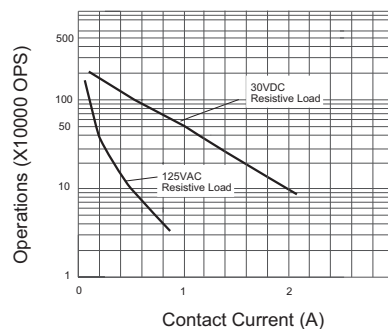

Disclaimer

This datasheet is for the customers' reference. All the specifications are subject to change without notice. We could not evaluate all the performance and all the parameters for every possible application. Thus the user should be in a right position to choose the suitable product for their own application. If there is any query, please contact Hongfa for the technical service. However, it is the user's responsibility to determine which product should be used only.

© 2006 Xiamen Hongfa Electroacoustic Co., Ltd. All rights of Hongfa are reserved.